

PN-L752B

寸法図

Dimensional Drawing

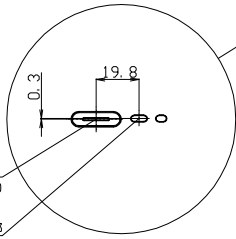
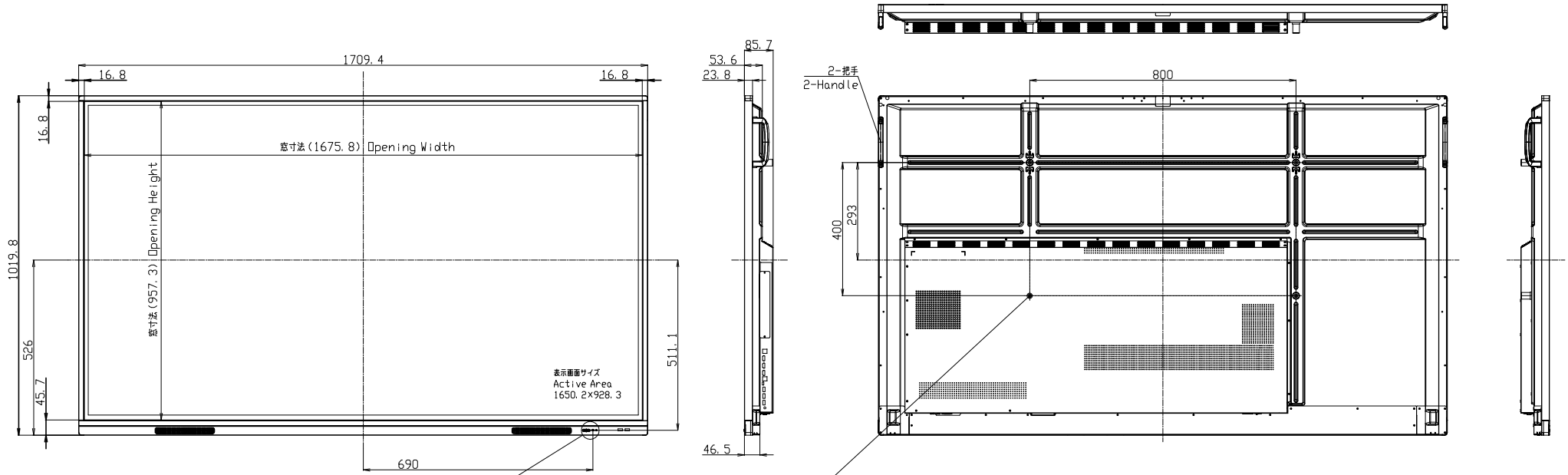

電源ボタン / 電源LED
Power button / Power LED

リモコン受光部
Remote control sensor

取り付け金具固定ネジ
Bracket fixing screw

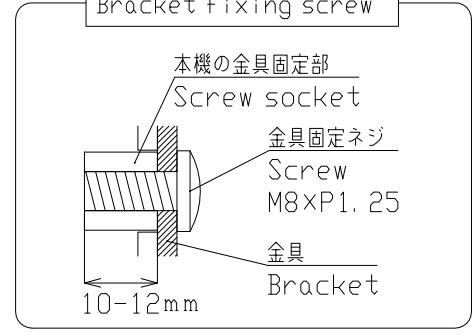

単位 : mm
Unit : mm

質量	約 49.5 kg
Weight	Approx