

シャープ製LED照明器具 配光データシート 形名 DL-MU400N+DL-M400N

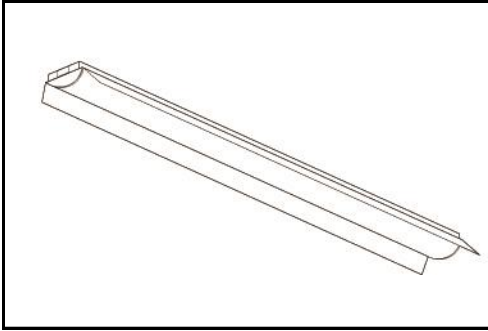

器具光束	5,050 lm
上方光束	2 lm
下方光束	5,048 lm
最大光度	1,744 cd

光源	LEDライトモジュール
光源型名	DL-M400N
口金形式	-
色温度	5000K
保守率	良:0.81, 中:0.77, 否:0.68
最大取付間隔	a-a 1.4H b-b 1.5H
備考	

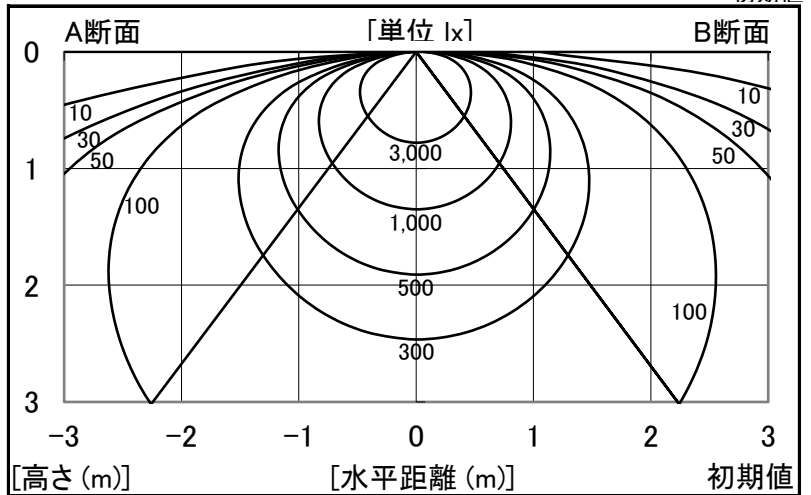

角度	光度 [cd/1,000lm]		
	A-A'	B-B'	C-C'
0	344	345	-
10	338	339	-
20	319	321	-
30	292	292	-
40	258	254	-
50	217	208	-
60	166	156	-
70	101	98	-
80	24	38	-
90	0	1	-
100	0	0	-
110	0	0	-
120	0	0	-
130	0	0	-
140	0	0	-
150	0	0	-
160	0	0	-
170	0	0	-
180	0	0	-

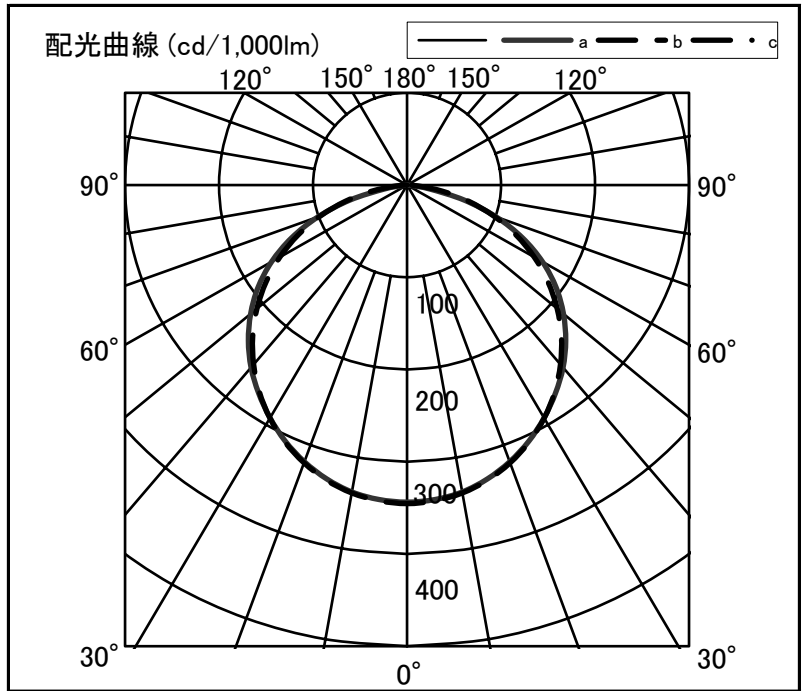

反射率	天井						70						50						30		20		0	
	壁		80		30		70		50		30		50		30		30		10		0			
室指数	照明率 (×0.01)																							
0.6	62	57	48	45	39	37	61	56	47	45	38	37	45	44	38	37	37	36	32	30				
0.8	74	68	60	56	50	48	72	66	59	56	50	48	57	54	49	47	48	47	42	40				
1.0	83	74	69	64	59	56	80	73	67	63	58	56	65	61	57	55	56	54	49	47				
1.25	91	81	77	71	68	64	88	79	76	70	67	63	72	68	65	62	63	61	57	55				
1.5	96	85	84	76	75	69	93	83	82	75	74	69	78	73	71	68	69	67	62	60				
2.0	104	90	93	83	85	77	100	89	91	82	83	77	86	80	80	75	77	74	70	68				
2.5	109	94	100	88	92	83	105	92	97	87	90	82	92	85	86	81	82	79	76	74				
3.0	112	96	104	91	97	87	108	95	101	90	95	86	95	88	90	84	86	83	79	77				
4.0	117	99	110	95	104	92	113	98	107	94	102	91	101	92	96	89	92	87	85	83				
5.0	120	101	114	98	109	95	115	100	110	97	106	94	104	95	100	92	95	90	88	86				
7.0	123	103	119	101	115	99	118	102	115	100	111	98	107	98	105	96	99	94	92	90				
10	126	105	122	103	119	102	121	104	118	102	116	100	110	100	108	98	102	97	95	93				