

シャープ製LED照明器具 配光データシート 形名 DL-MK400M+DL-M600N

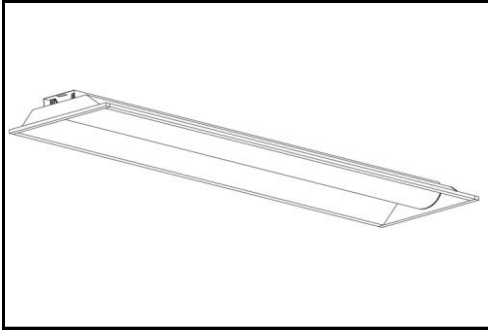

器具光束	6,890 lm
上方光束	0 lm
下方光束	6,890 lm
最大光度	2,315 cd

光源	LEDライトモジュール
光源型名	DL-M600N
口金形式	-
色温度	5000K
保守率	良:0.81, 中:0.77, 否:0.68
最大取付間隔	a-a 1.4H b-b 1.5H
備考	

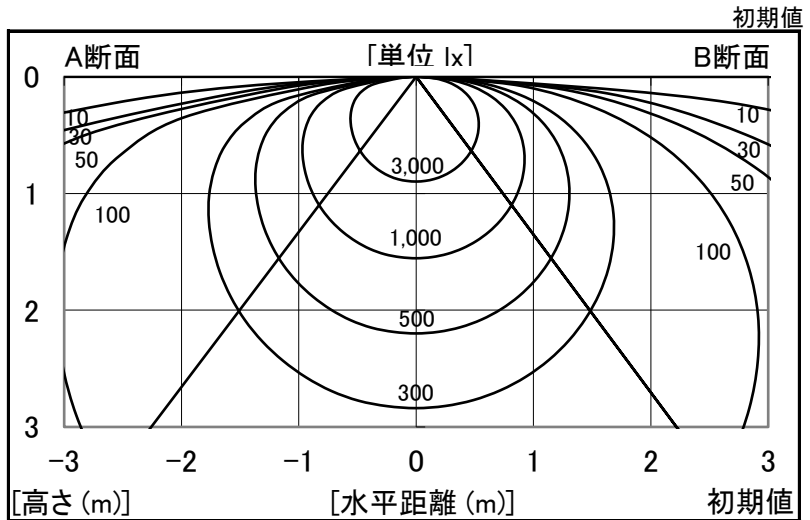

角度	光度 [cd/1,000lm]		
	A-A'	B-B'	C-C'
0	336	336	-
10	331	330	-
20	313	312	-
30	286	283	-
40	252	245	-
50	213	200	-
60	173	148	-
70	125	91	-
80	56	33	-
90	0	0	-
100	0	0	-
110	0	0	-
120	0	0	-
130	0	0	-
140	0	0	-
150	0	0	-
160	0	0	-
170	0	0	-
180	0	0	-

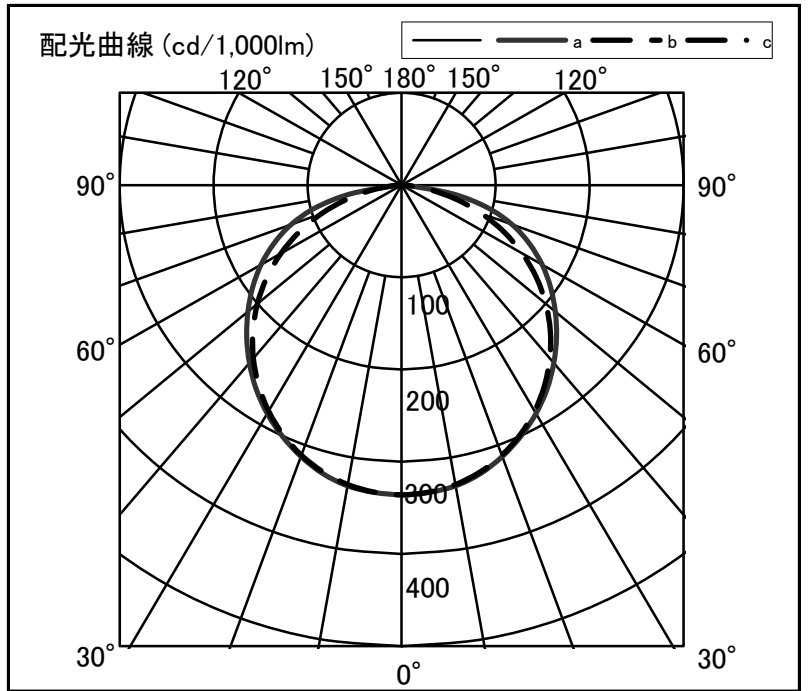

反射率	天井						70						50						30		20		0	
	70		50		30		70		50		30		50		30		30		10		0			
室指数	照明率 (×0.01)																							
0.6	62	57	47	45	38	37	60	56	46	44	38	37	45	43	37	36	36	36	31	29				
0.8	74	67	59	55	50	48	72	66	58	55	49	47	56	53	48	47	47	46	41	39				
1.0	82	74	68	63	58	55	79	72	66	62	57	55	64	60	56	54	55	53	48	46				
1.25	90	80	76	70	67	63	87	78	75	69	66	62	71	67	64	61	62	60	56	54				
1.5	95	84	83	75	74	68	92	82	81	74	72	68	77	72	70	67	68	65	61	59				
2.0	103	90	92	82	84	76	100	88	90	81	82	76	85	79	79	74	76	73	69	67				
2.5	108	93	99	87	91	82	104	92	96	86	89	81	91	84	85	80	81	78	74	72				
3.0	112	96	103	90	96	86	108	94	100	89	94	85	95	87	89	83	86	82	78	76				
4.0	116	99	110	95	104	91	112	98	106	94	101	90	100	91	96	88	91	87	84	82				
5.0	119	101	114	97	108	94	115	100	110	96	105	93	103	94	100	92	94	90	87	85				
7.0	123	103	118	101	114	98	118	102	114	99	111	97	107	97	104	95	99	93	91	89				
10	125	105	122	103	119	101	121	104	118	102	115	100	110	100	108	98	102	96	94	92				