

シャープ製LED照明器具 配光データシート 形名 DL-MF40PN+DL-M401N

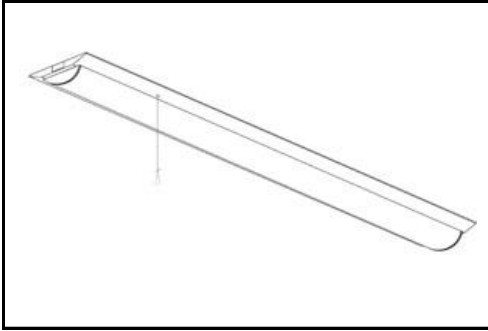

器具光束	5,100 lm
上方光束	245 lm
下方光束	4,855 lm
最大光度	1,552 cd

光源	LEDライトモジュール
光源型名	DL-M401N
口金形式	-
色温度	5000K
保守率	良:0.88, 中:0.86, 否:0.81
最大取付間隔	a-a 1.4H b-b 1.5H
備考	

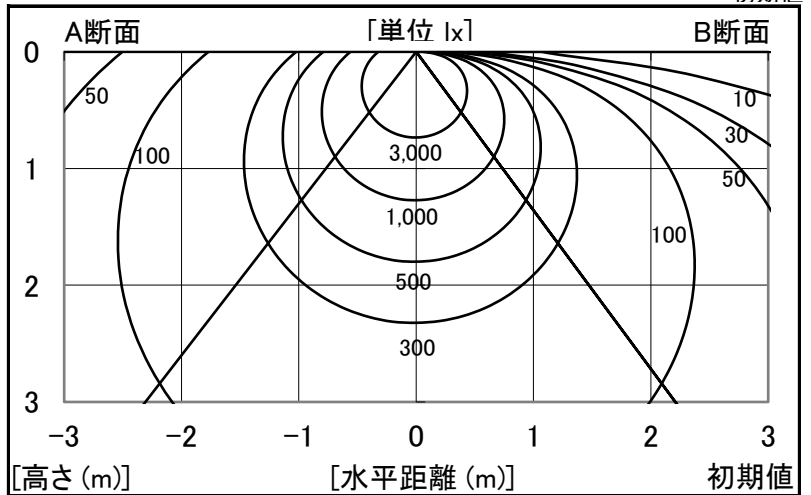

角度	光度[cd/1,000lm]		
	A-A'	B-B'	C-C'
0	304	303	-
10	300	297	-
20	286	281	-
30	263	255	-
40	233	220	-
50	198	179	-
60	160	132	-
70	123	81	-
80	87	30	-
90	58	1	-
100	37	0	-
110	20	0	-
120	6	0	-
130	0	0	-
140	0	0	-
150	0	0	-
160	0	0	-
170	0	0	-
180	0	0	-

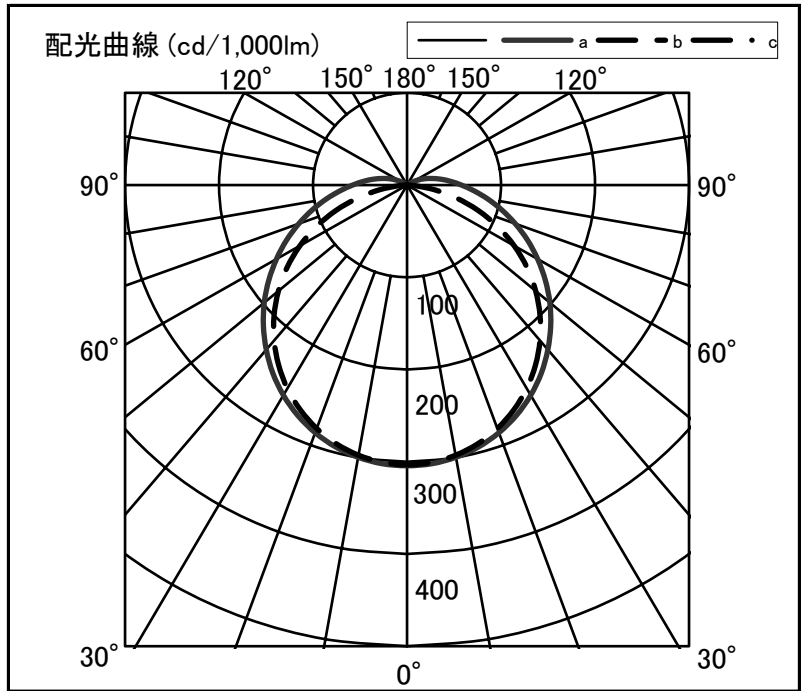

反射率	天井						70						50						30		20		0	
	70		50		30		70		50		30		50		30		30		10		0			
室指数	照明率(×0.01)																							
0.6	60	55	45	43	36	35	58	54	44	42	36	35	42	41	35	34	34	33	28	26				
0.8	72	65	57	53	47	45	69	63	56	52	47	45	53	51	45	44	44	43	38	35				
1.0	80	72	65	61	56	53	77	70	64	60	55	52	60	57	53	51	51	49	44	42				
1.25	87	78	74	68	64	60	84	76	72	66	63	59	68	64	60	58	58	56	51	49				
1.5	93	82	80	73	70	65	89	80	78	71	69	64	73	69	66	63	63	61	56	54				
2.0	101	87	89	80	80	73	96	85	86	78	78	72	81	75	74	70	71	68	64	61				
2.5	106	91	95	84	87	78	101	89	92	83	85	77	86	80	80	75	76	73	69	66				
3.0	109	94	100	88	92	82	105	91	96	86	90	81	90	83	85	79	80	77	73	70				
4.0	114	97	106	92	100	88	109	95	102	90	97	86	95	87	91	84	85	81	78	75				
5.0	117	99	110	95	105	91	112	97	106	93	101	90	99	90	95	87	89	84	81	78				
7.0	120	101	115	98	111	95	115	99	111	96	107	94	103	93	100	91	93	88	85	82				
10	123	103	119	101	116	99	118	101	115	99	112	97	106	96	104	94	97	91	89	86				