

シャープ製LED照明器具 配光データシート 形名 DL-MF400W+DL-M400L

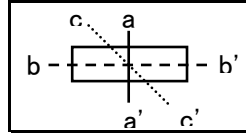
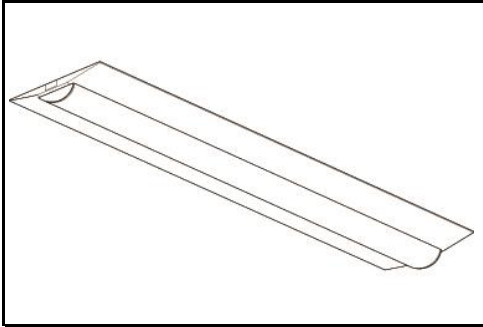

器具光束	4,450 lm
上方光束	186 lm
下方光束	4,264 lm
最大光度	1,364 cd

初期値

光源	LEDライトモジュール
光源型名	DL-M400L
口金形式	-
色温度	3000K
保守率	良:0.83, 中:0.81, 否:0.77
最大取付間隔	a-a 1.4H b-b 1.5H
備考	

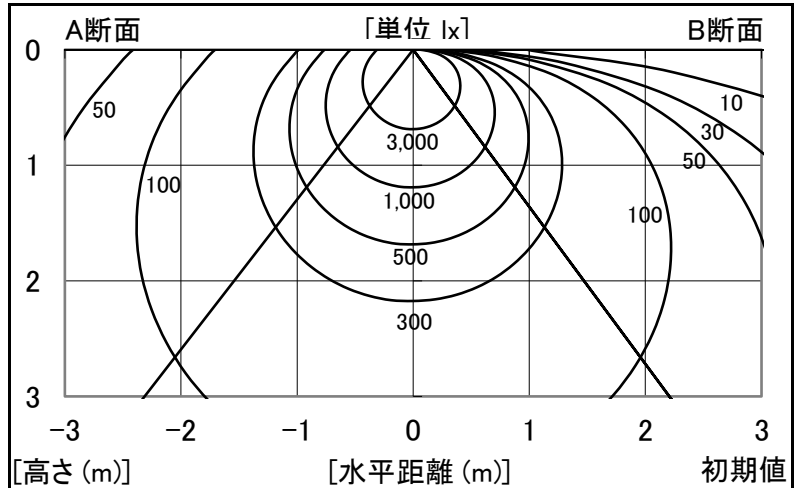

角度	光度[cd/1,000lm]		
	A-A'	B-B'	C-C'
0	307	305	-
10	302	299	-
20	288	282	-
30	265	256	-
40	235	221	-
50	200	179	-
60	161	132	-
70	123	81	-
80	88	30	-
90	62	1	-
100	36	0	-
110	13	0	-
120	0	0	-
130	0	0	-
140	0	0	-
150	0	0	-
160	0	0	-
170	0	0	-
180	0	0	-

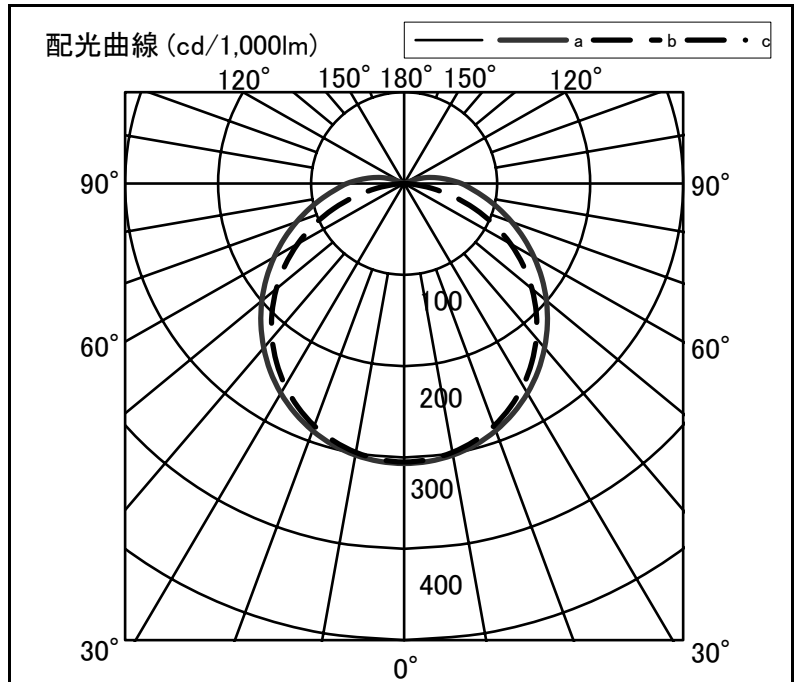

反射率	天井		80		70		50		30		20		0							
	壁	床	70	50	30	70	50	30	50	30	30	10	10	0						
室指数	照明率(×0.01)																			
0.6	60	56	45	43	36	35	58	54	44	42	36	35	43	41	35	34	34	33	29	27
0.8	72	65	57	53	47	45	69	64	56	53	47	45	53	51	45	44	44	43	38	36
1.0	80	72	65	61	56	53	77	70	64	60	55	52	61	58	53	51	51	50	45	42
1.25	87	78	74	68	64	60	84	76	72	66	63	59	68	64	60	58	58	56	51	49
1.5	93	82	80	73	70	65	89	80	78	71	69	64	73	69	66	63	63	61	56	54
2.0	101	88	89	80	80	73	97	85	86	78	78	72	81	75	75	70	71	68	64	61
2.5	106	91	95	84	87	82	101	89	92	83	85	77	86	80	80	75	76	73	69	66
3.0	109	94	100	88	93	82	105	92	97	86	90	81	90	83	85	79	80	77	73	70
4.0	114	97	106	92	100	88	109	95	102	90	97	86	95	87	91	84	86	82	78	75
5.0	117	99	110	95	105	91	112	97	106	93	101	90	99	90	95	87	89	85	81	79
7.0	120	101	115	98	111	95	115	99	111	96	107	94	103	93	100	91	93	88	86	83
10	123	103	119	101	116	99	118	101	115	99	112	97	106	96	104	94	97	92	89	86