

シャープ製LED照明器具 配光データシート 形名 DL-MF300N+DL-M510N

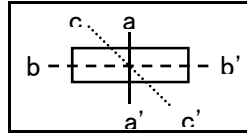
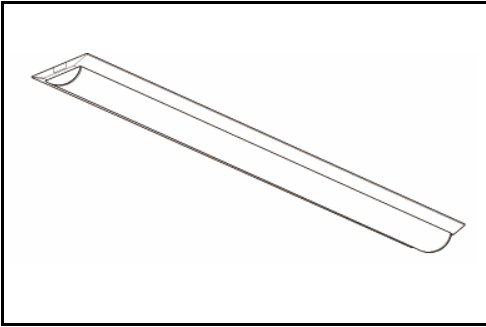

器具光束	3,200 lm
上方光束	164 lm
下方光束	3,036 lm
最大光度	950 cd

初期値

光源	LEDライトモジュール
光源型名	DL-M510N
口金形式	-
色温度	5000K
保守率	良:0.83, 中:0.81, 否:0.77
最大取付間隔	a-a 1.4H b-b 1.5H
備考	

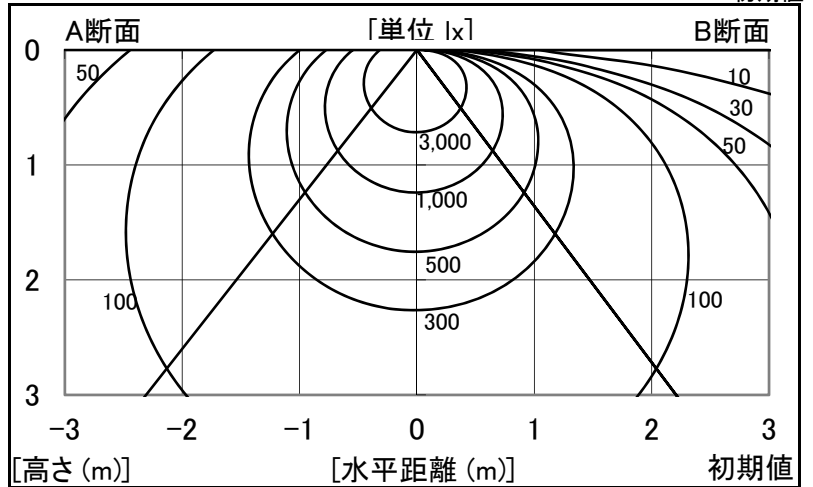

角度	光度[cd/1,000lm]		
	A-A'	B-B'	C-C'
0	297	297	-
10	293	291	-
20	279	276	-
30	257	251	-
40	228	218	-
50	194	178	-
60	158	132	-
70	121	82	-
80	87	33	-
90	58	2	-
100	37	1	-
110	20	0	-
120	6	0	-
130	0	1	-
140	0	1	-
150	0	0	-
160	0	0	-
170	0	0	-
180	0	0	-

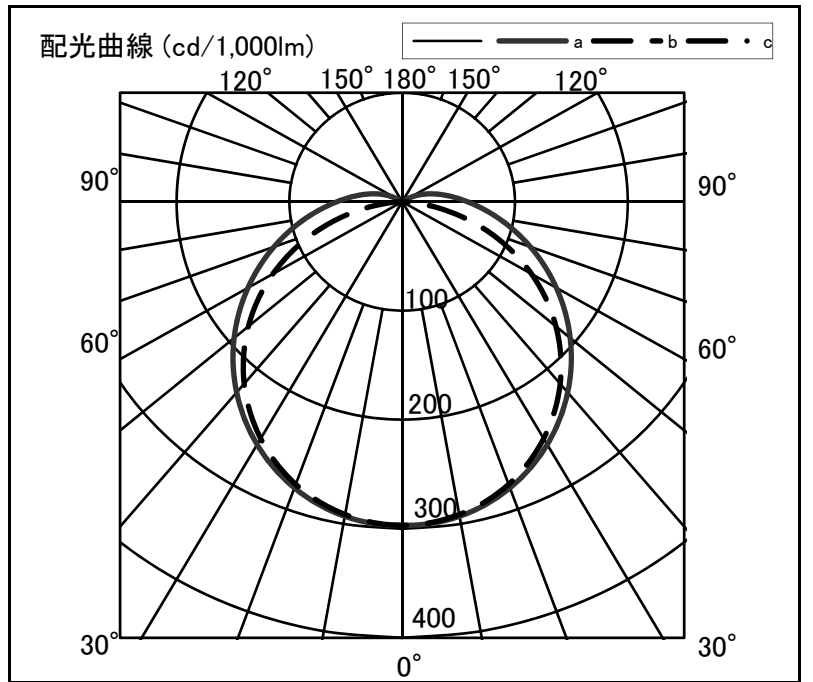

反射率	天井 80						70						50						30		20		0	
	壁 70		50		30		70		50		30		50		30		30		10		0			
床	30	10	30	10	30	10	30	10	30	10	30	10	30	10	30	10	30	10	30	10	30	10	10	0
室指数	照明率(×0.01)																							
0.6	60	55	45	43	36	35	58	54	44	42	36	35	42	41	35	34	34	33	28	26				
0.8	72	65	57	53	47	45	69	63	56	52	47	45	53	51	45	44	44	43	38	35				
1.0	80	72	65	61	56	53	77	70	64	60	55	52	60	57	53	51	51	49	44	42				
1.25	87	78	74	68	64	60	84	76	72	66	63	59	68	64	60	58	58	56	51	49				
1.5	93	82	80	73	70	65	89	80	78	71	69	64	73	69	66	63	63	61	56	54				
2.0	101	87	89	80	80	73	96	85	86	78	78	72	81	75	74	70	71	68	64	61				
2.5	106	91	95	84	87	78	101	89	92	83	85	77	86	80	80	75	76	73	69	66				
3.0	109	94	100	88	92	82	105	91	96	86	90	81	90	83	85	79	80	77	73	70				
4.0	114	97	106	92	100	88	109	95	102	90	97	86	95	87	91	84	85	81	78	75				
5.0	117	99	110	95	105	91	112	97	106	93	101	90	99	90	95	87	89	84	81	78				
7.0	120	101	115	98	111	95	115	99	111	96	107	94	103	93	100	91	93	88	85	82				
10	123	103	119	101	116	99	118	101	115	99	112	97	106	96	104	94	97	91	89	86				