

シャープ製LED照明器具 配光データシート 形名 DL-A002N

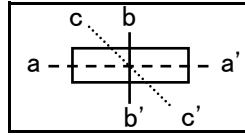

器具光束	4,400 lm
上方光束	0 lm
下方光束	4,400 lm
最大光度	1,755 cd
	初期値

光源	LED
形式	スクエア型
パネル	半透明パネル
色温度	4,800K
保守率	0.8
最大取付間隔	a-a 1.4H b-b 1.4H
備考	

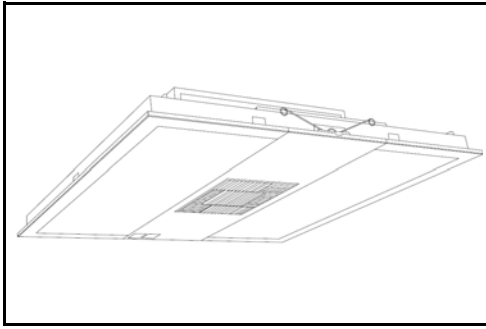
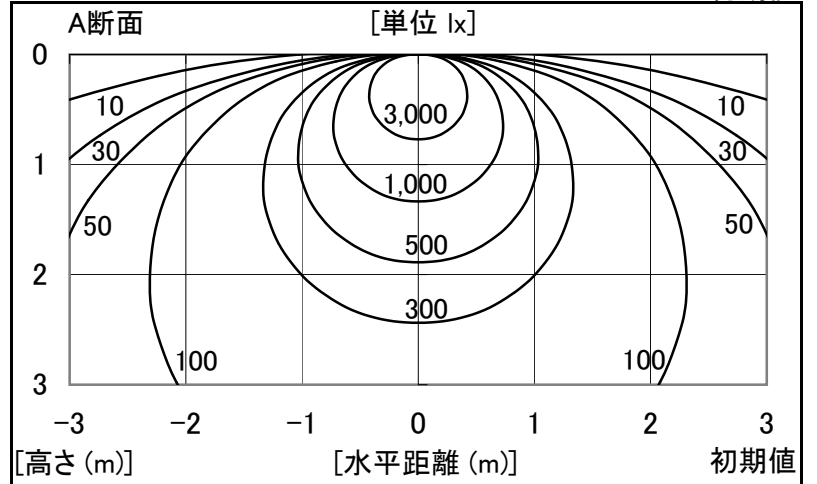

角度	光度 [cd/1,000lm]		
	A-A'	B-B'	C-C'
0	399	399	-
10	391	391	-
20	363	363	-
30	320	320	-
40	265	265	-
50	202	202	-
60	139	139	-
70	79	79	-
80	30	30	-
90	2	2	-
100	0	0	-
110	0	0	-
120	0	0	-
130	0	0	-
140	0	0	-
150	0	0	-
160	0	0	-
170	0	0	-
180	0	0	-

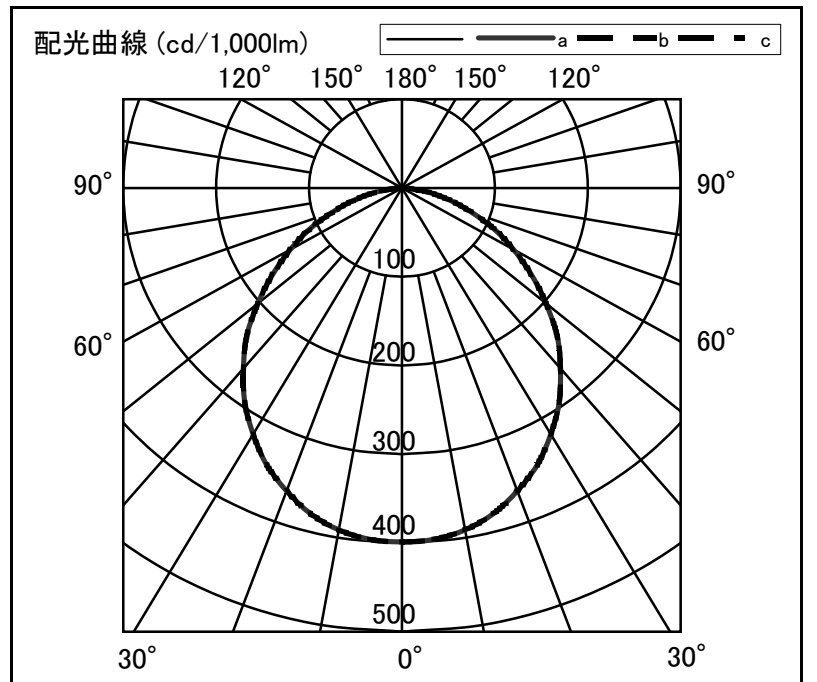

反射率	80								70								50								30		20		0		
	天井		壁		床		室指数		天井		壁		床		室指数		天井		壁		床		室指数		天井		壁		床		室指数
0.6	65	60	51	48	42	41	63	59	50	48	42	41	49	47	41	40	40	40	35	34											
0.8	77	70	63	59	54	52	75	69	62	58	53	51	60	57	52	51	51	50	46	44											
1.0	85	77	72	67	63	59	83	75	70	66	62	59	68	64	60	58	59	57	53	51											
1.25	93	82	80	73	71	67	90	81	78	73	70	66	75	71	68	65	66	64	60	58											
1.5	98	86	86	78	78	72	95	85	84	77	76	71	81	75	74	70	72	69	65	63											
2.0	105	92	95	85	87	80	102	90	93	84	85	79	88	82	82	78	79	76	73	71											
2.5	110	95	101	89	94	88	106	93	98	88	92	84	93	86	88	82	84	81	78	76											
3.0	113	97	105	92	99	88	109	96	102	91	96	87	97	89	92	86	88	84	81	79											
4.0	118	100	111	96	106	93	113	99	108	95	103	92	101	93	98	90	93	88	86	84											
5.0	120	102	115	99	110	96	116	100	111	97	107	95	104	95	101	93	96	91	89	87											
7.0	123	104	119	101	115	102	119	102	115	100	112	98	108	98	105	96	100	94	92	90											
10	126	105	123	103	120	99	121	104	118	102	116	101	111	100	109	99	103	97	95	93											