

シャープ製LED照明器具 配光データシート 形名 DL-D056WW

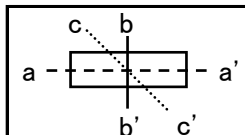
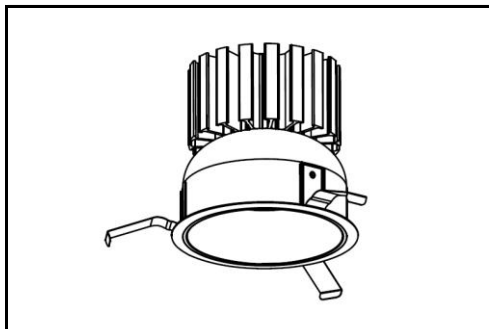

器具光束	7,080 lm
上方光束	0 lm
下方光束	7,080 lm
最大光度	6,790 cd

初期値

光源	LED
形式	ダウンライト
埋込穴径	Φ150
色温度	4000K
保守率	良:0.76 中:0.72 否:0.64
最大取付間隔	a-a 1.3H
備考	

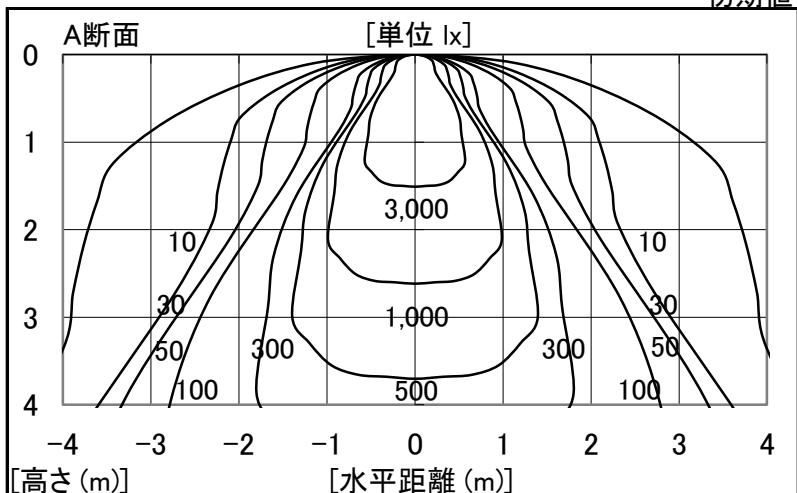

角度	光度[cd/1,000lm]		
	A-A'	B-B'	C-C'
0	953	-	-
10	959	-	-
20	855	-	-
30	467	-	-
40	182	-	-
50	37	-	-
60	25	-	-
70	18	-	-
80	5	-	-
90	0	-	-
100	0	-	-
110	0	-	-
120	0	-	-
130	0	-	-
140	0	-	-
150	0	-	-
160	0	-	-
170	0	-	-
180	0	-	-

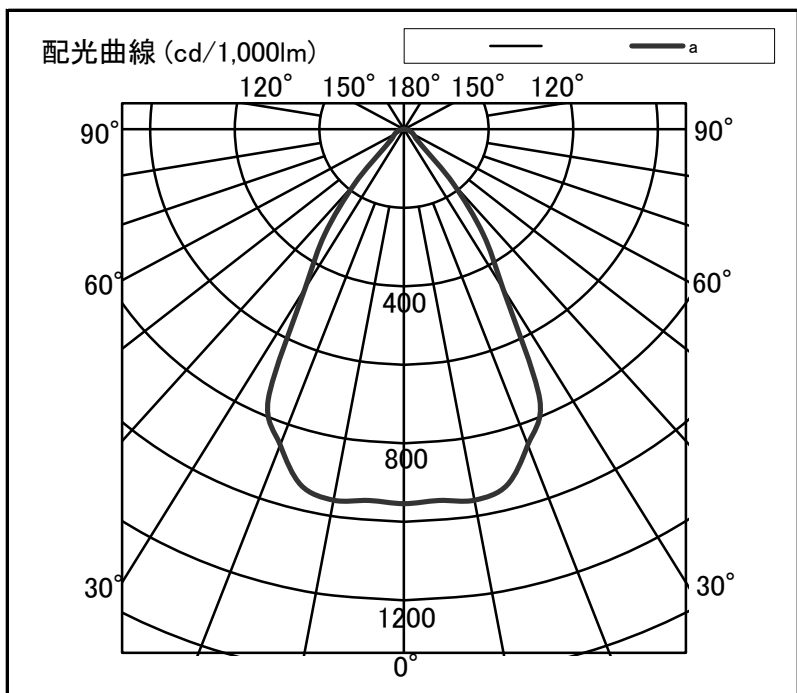

反射率	天井		80		70		50		30		20		0							
	壁	床	70	50	30	70	50	30	50	30	30	10	0							
室指数	照明率(×0.01)																			
0.6	91	84	81	77	76	73	89	83	81	77	75	73	79	76	75	73	74	73	70	69
0.8	99	90	89	84	84	80	97	89	89	84	83	80	87	83	82	80	81	79	77	76
1.0	104	93	95	88	89	85	102	92	94	88	88	84	91	87	87	84	85	83	81	80
1.25	108	96	100	92	95	89	106	95	99	91	93	88	96	90	91	87	89	87	85	83
1.5	112	98	104	94	98	91	109	97	102	94	97	91	99	92	94	90	92	89	87	86
2.0	116	101	109	98	104	95	113	100	107	97	102	94	103	95	99	93	96	92	90	89
2.5	119	103	113	100	108	97	115	101	110	99	106	97	105	97	102	95	98	94	92	91
3.0	121	104	116	101	111	99	117	102	113	100	109	98	107	99	104	97	100	96	94	92
4.0	123	105	119	103	115	101	119	104	116	102	113	101	110	100	107	99	102	97	96	94
5.0	125	106	121	104	118	103	121	105	118	103	115	102	111	101	109	100	104	99	97	95
7.0	127	107	124	105	122	104	122	105	120	104	118	103	113	102	111	102	105	100	98	97
10	128	107	126	106	124	106	124	106	122	105	120	105	114	103	113	103	107	101	100	98