

シャープ製LED照明器具 配光データシート 形名 DL-D054W

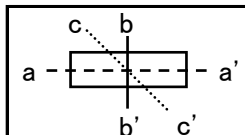
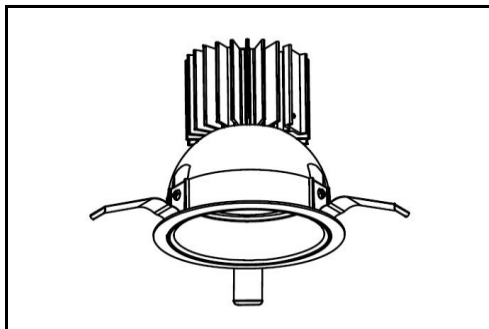

器具光束	3,120 lm
上方光束	0 lm
下方光束	3,120 lm
最大光度	3,250 cd

初期値

光源	LED
形式	ダウンライト
埋込穴径	Φ125
色温度	4000K
保守率	良:0.76 中:0.72 否:0.64
最大取付間隔	a-a 0.96H
備考	

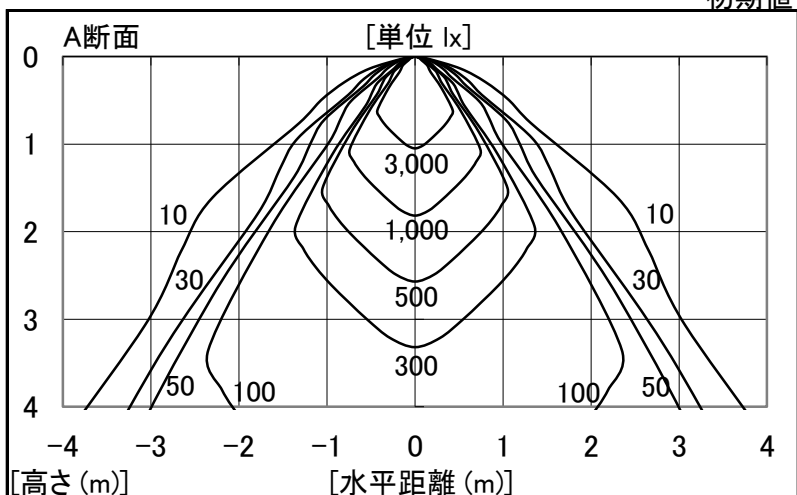

角度	光度[cd/1,000lm]		
	A-A'	B-B'	C-C'
0	1042	-	-
10	886	-	-
20	730	-	-
30	608	-	-
40	203	-	-
50	37	-	-
60	6	-	-
70	1	-	-
80	0	-	-
90	0	-	-
100	0	-	-
110	0	-	-
120	0	-	-
130	0	-	-
140	0	-	-
150	0	-	-
160	0	-	-
170	0	-	-
180	0	-	-

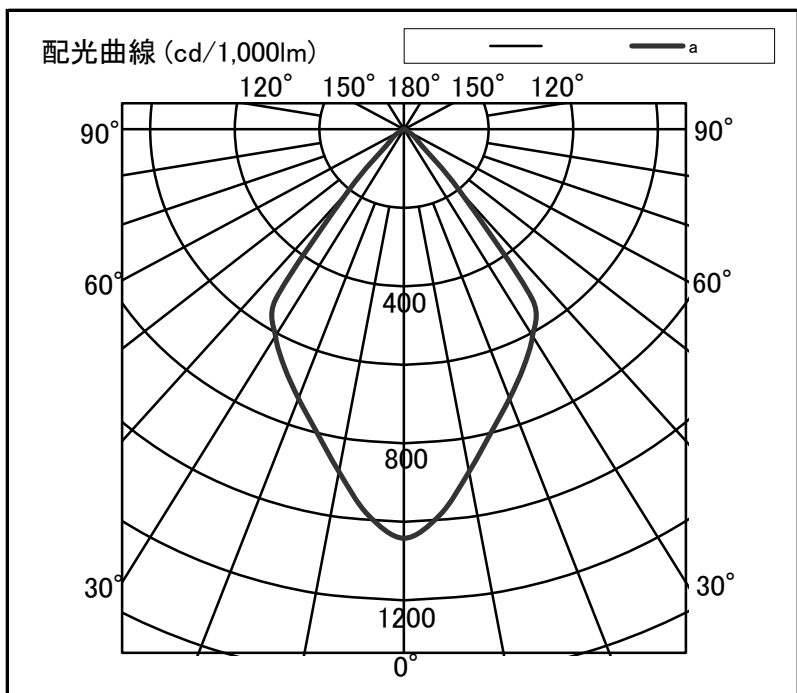

反射率	天井		80		70		50		30		20		0							
	壁	床	70	50	30	70	50	30	50	30	30	10	0							
室指数	照明率(×0.01)																			
0.6	88	81	78	74	72	70	87	80	77	74	72	70	76	73	71	69	70	69	66	65
0.8	97	88	88	82	82	78	95	87	87	82	81	78	85	81	80	78	79	77	75	74
1.0	103	93	94	88	88	84	101	92	93	87	88	84	91	86	86	83	84	82	80	79
1.25	108	96	100	92	94	88	106	95	98	91	93	88	95	90	91	87	89	86	84	83
1.5	112	98	104	94	98	91	109	97	102	94	97	91	99	92	94	90	92	89	87	86
2.0	116	101	110	98	104	95	113	100	107	97	103	95	103	96	99	94	96	92	91	89
2.5	119	103	113	100	109	98	116	102	111	99	106	97	106	98	102	96	99	95	93	91
3.0	121	104	116	101	112	99	117	103	113	101	109	99	107	99	104	97	100	96	94	93
4.0	123	105	119	103	116	102	120	104	116	102	113	101	110	100	107	99	103	98	96	95
5.0	125	106	122	104	118	103	121	105	118	103	115	102	111	101	109	100	104	99	97	96
7.0	127	107	124	106	122	105	123	106	120	105	118	104	113	103	112	102	106	100	99	97
10	128	107	126	107	124	106	124	106	122	105	121	105	114	103	113	103	107	101	100	98